

OOYA

Radial Drills

UNIQUE IN DRILLING TAPPING AND BORING ABILITY

RE3-1600 · 2000 · 2500 · 3000



OOYA MACHINERY WORKS CO., LTD.

SPINDLE HEAD

All the operation levers and switches are set of the front side of the head to get maximum working efficiency. Coupled with preselection control device, a vast range of spindle speeds (16 steps, 20–2180 R.P.M.) and feed range (0.04–3.17 mm) can meet any kinds of works. The machine is of transmission type, made of highly tenacious semi-steel. The internal surface of the spindle cylinder is roller-pressed for longer life and maintenance of high accuracy. Starting and stopping of operation is simple and easy for the built-in multi-disc clutches. All the rotating portions are automatically lubricated by lubricant pump through quality filters.

SPINDLE:

The spindle, made of high grade nitro-steel, is supported by cylindrical roller bearing, always maintaining smooth rotation. Owing to the special construction that the tapered portion of the spindle is even in heavy boring job. The spindle nose runout is within 0.01 mm (0.0004") tolerance. The quill is of nitro-hardened and provided with precision rack gears.

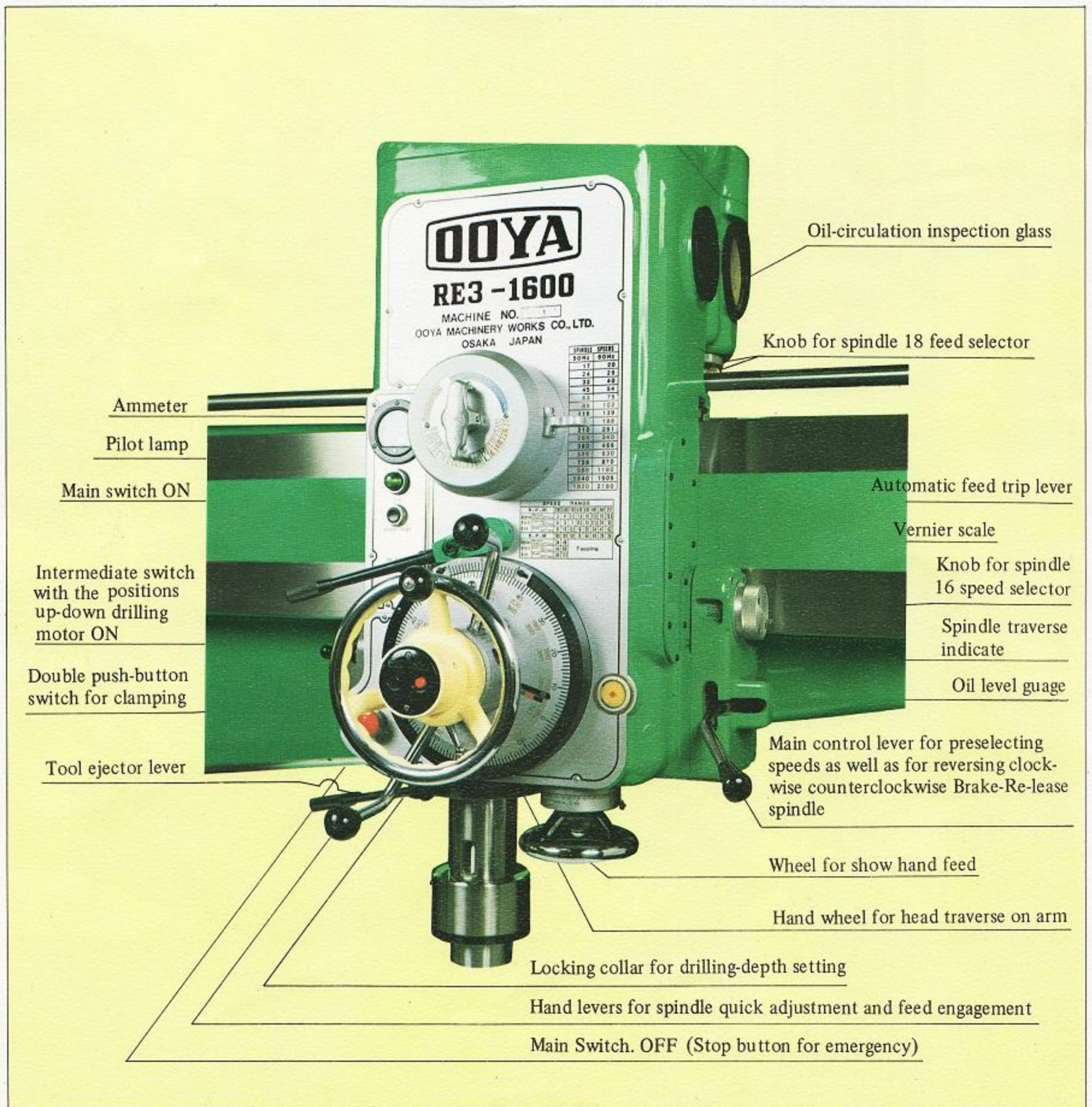

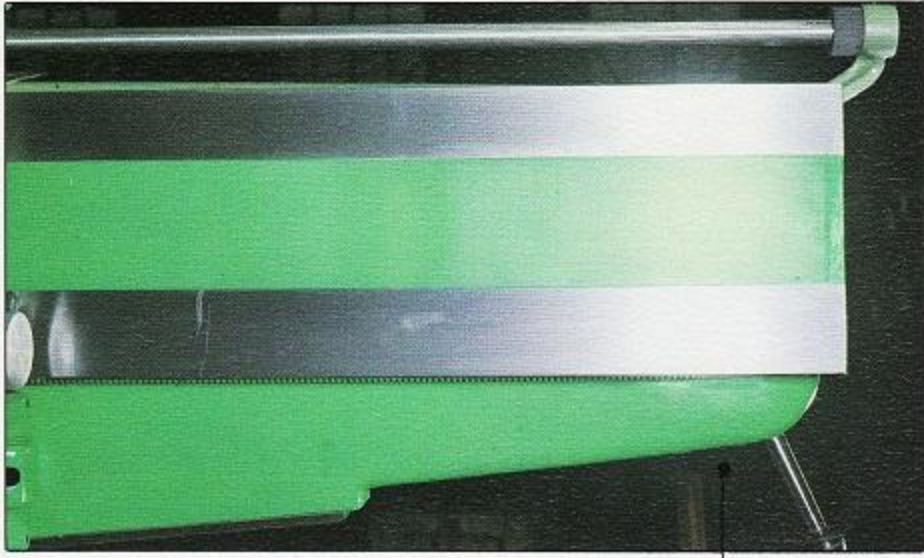

ARM:

The arm is made of high grade semi-steel, and its sliding way is hardened and ground. It is so designed as to rotate through 360° and to be durable against any bend or distortion.

GEARINGS:

Gears and spindle shafts are of nickel-chrome steel and duly ground, and the built-in antifriction bearings keep smooth machine operation.

AUTOMATIC SIZING FEED:

This device can perform an automatic through feed of 400 mm (16") which is equivalent to the maximum spindle stroke. The device is provided with a vernier scale of 0.1 mm (0.0004") reading accuracy.

SPINDLE RELEASING DEVICE:

When the spindle releasing dial is set at "RELEASE", the spindle is released from gearings and takes vain rotation which gives easy resetting of tools.

CLAMPING SYSTEM:

Electric clamping system is employed. Head, column and arm being separately clamped from the mechanical point of view, there is no danger at all even if two buttons, clamping and unclamping are pushed simultaneously.

ELECTRICALS:

All the electrics operated by push-button at the front of the machine, are built in the control box at the rear of the arm, protected against discharge from the motors.

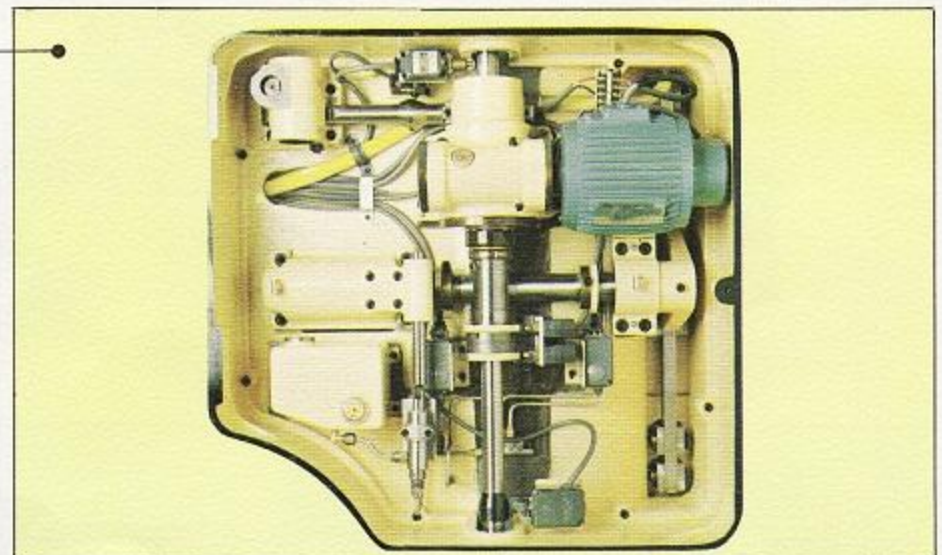
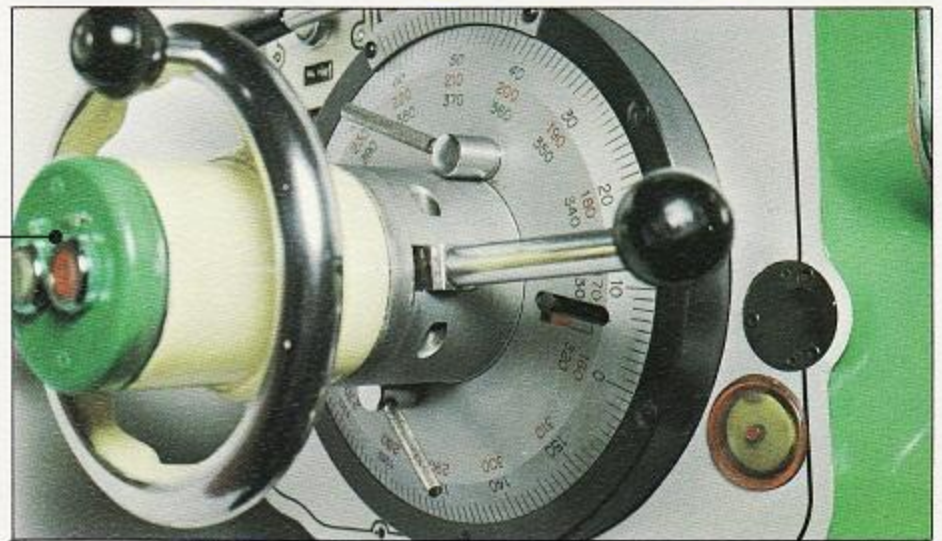
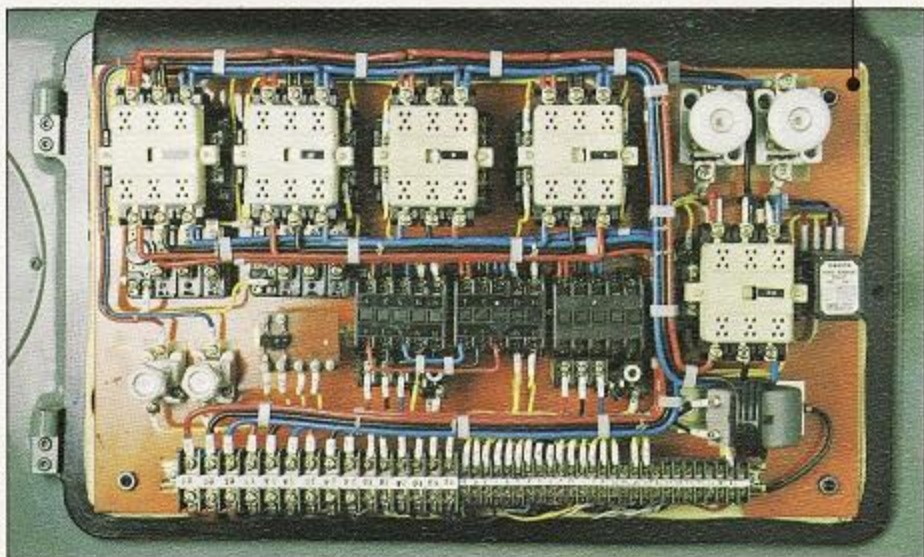

■ SPECIFICATIONS

RE3-1600. RE3-2000. RE3-2500. RE3-3000 (Preselect Controll)

Model		RE3-1600	RE3-2000	RE3-2500	RE3-3000
MACHINING CAPACITY					
Drilling, Solid steel	in. (mm)	3 (75)			
Drilling, Cast Iron	in. (mm)	3 ⁵ / ₈ (90)			
Boring in Steel	in. (mm)	7 ⁷ / ₈ (200)			
Boring in Cast Iron		11 (280)			
SPINDLE					
Diameter of spindle and Quill	in. (mm)	3, 3 ³ / ₄ (75/95)			
Vertical Travel	in. (mm)	15 ³ / ₄ (400)			
Morse-Taper		No. 5		No. 5	
Speed R.P.M. (16 speeds)		50 Hz. 16.5 ~ 1,820		60 Hz. 20 ~ 2,180	
Feeds (18 feeds)	in/rev (mm/rev)	0.0015 ~ 0.125 0.04 ~ 3.17			
DIMENSIONS					
Column diameter (A)	in. (mm)	16 ³ / ₈ (416)	19 ¹ / ₁₆ (500)		23 ⁵ / ₈ (600)
Max. distance, column Surface to Spindle Center (B)	in. (mm)	63 ³ / ₄ (1,620)	79 ¹ / ₂ (2,020)	99 ¹ / ₄ (2,520)	123 ¹ / ₈ (3,125)
Min. distance, column Surface to Spindle Center (C)	in. (mm)	13 ³ / ₄ (350)	16 ¹ / ₈ (410)	16 ¹ / ₂ (420)	16 ³ / ₄ (425)
Horizontal travel of Spindle Head	in. (mm)	50 (1,270)	63 ³ / ₈ (1,610)	82 ⁵ / ₈ (2,100)	106 ¹ / ₄ (2,700)
Max. distance, base to spindle (D)	in. (mm)	61 ¹ / ₂ (1,575)	66 ⁷ / ₈ (1,700)	70 ⁷ / ₈ (1,800)	92 ¹ / ₈ (2,340)
Min. distance, base to spindle (E)	in. (mm)	14 ¹ / ₈ (360)	19 (480)	22 ¹ / ₄ (565)	23 ¹ / ₄ (590)
Vertical travel of arm		32 ¹ / ₄ (820)	32 ¹ / ₄ (820)	32 ⁷ / ₈ (835)	53 (1,350)
Max. height, floor to top of Column (F)	in. (mm)	111 ³ / ₈ (2,830)	116 ³ / ₄ (2,965)	127 ⁵ / ₈ (3,240)	145 ⁵ / ₈ (3,700)
Base Size (G x H x I)	in. (mm)	100 ³ / ₈ x 40 ¹ / ₂ x 9 ⁷ / ₁₆ (2,550 x 1,030 x 240)	121 ¹ / ₄ x 49 ¹ / ₄ x 10 (3,080 x 1,250 x 250)	141 x 49 ¹ / ₄ x 11 (3,580 x 1,250 x 280)	170 ¹ / ₂ x 53 x 11 ³ / ₄ (4,330 x 1,350 x 300)
MOTORS					
Spindle drive	HP (kW)	10 (7.5)			
Arm elevation	HP (kW)	3 (2.2)	5 (3.7)		7 ¹ / ₂ (5.5)
Clamping	HP (kW)	1 ¹ / ₂ (1)	2 (1.5)		5 (3.7)
Coolant pump	W	40			
NET WEIGHT (Approx)					
	Lb.	12,100	15,000	19,800	31,900
	kg	5,500	6,800	9,000	14,500

(These specifications and weight may be changed without notice)

■ OUTLINE VIEW

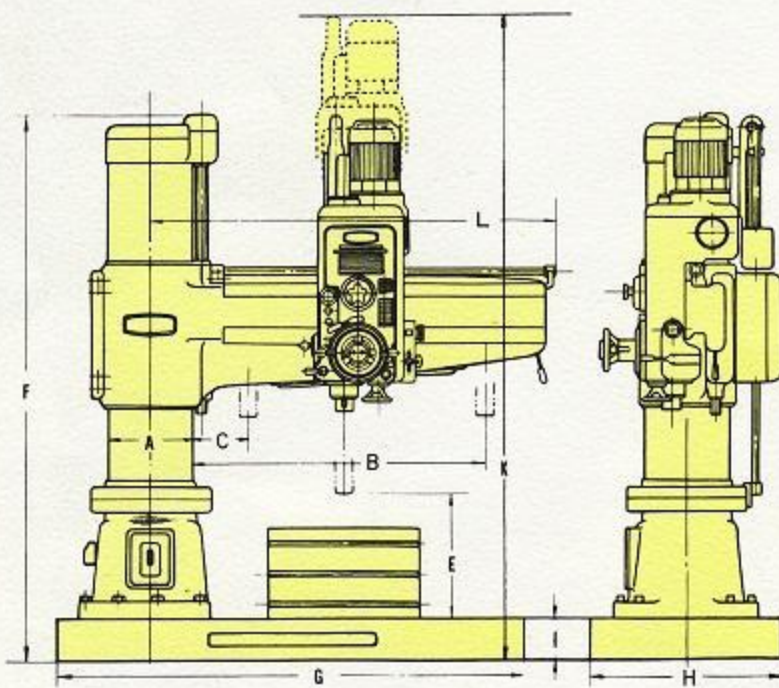

● BOX TABLE

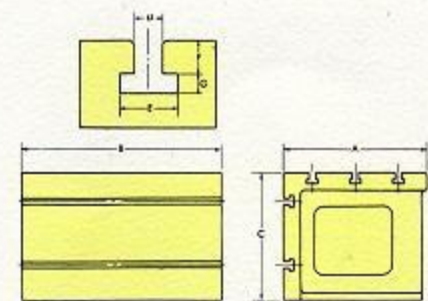

	RE3-1600	RE3-2000-3000
A	500	750
B	750	750
C	450	600
D	24	24
E	42	42
F	24	24
G	18	18

Printed in Japan

OOYA